

**SWISSDIS**



Swissdis AG  
Grasweg 7  
CH-4911 Schwarzhäusern

Tel.: +41 62 919 44 00  
Fax: +41 62 919 44 01  
[info@swissdis.ch](mailto:info@swissdis.ch)  
[www.swissdis.ch](http://www.swissdis.ch)



# SPECIFICATIONS

Automotive Grade and Flexible Termination

**MCFA - Series**

Version June 2023

**Automotive Grade Multilayer Ceramic Chip Capacitor**



**■Features**

- Product is suitable for the sensing module on the automobile engines and drive, and the vehicle electronic terminal equipment
- AEC-Q200 Compliance

**■Construction**

**Flexible Termination**

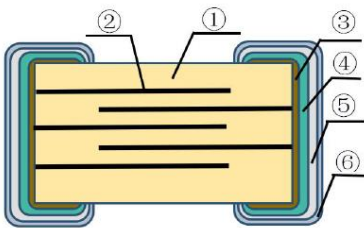

①	Ceramic Dielectric	④	Conductive Resin
②	Ni Electrode	⑤	Ni Coating
③	Cu Electrode	⑥	Sn Coating

**Barrier Termination**

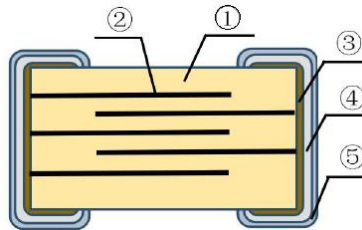

①	Ceramic Dielectric	④	Ni Coating
②	Ni Electrode	⑤	Sn Coating
③	Cu Electrode		

**■Dimensions**

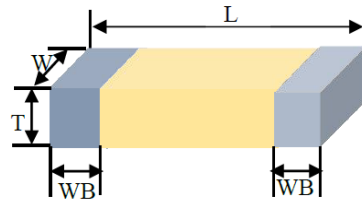

Unit: mm

Type	Size (Inch)	L	W	T	WB	Notes
01	0201	0.60±0.03	0.30±0.05	0.30±0.05	0.30±0.05	C ≤ 47nF
		0.60±0.05				C > 47nF
02	0402	1.00±0.05	0.50±0.05	0.50±0.05	0.25±0.05	C < 1uF
		1.00±0.15				1uF ≤ C < 10uF
03	0603	1.60±0.10	0.80±0.10	0.80±0.10	0.35±0.20	C ≤ 1uF
		1.60±0.20				C > 1uF
05	0805	2.00±0.20	1.25±0.20	0.80±0.20	0.50±0.20	C ≤ 0.47uF
				1.25±0.20		C > 0.47uF
06	1206	3.20±0.30	1.60±0.30	0.80±0.20	0.60±0.30	-
				1.25±0.20		
				1.60±0.30		
10	1210	3.20±0.30	2.50±0.30	≤ 2.80	0.60±0.30	-
08	1808	4.50±0.40	2.00±0.20	≤ 2.20	0.60±0.30	-
12	1812	4.50±0.40	3.20±0.30	≤ 3.50	0.60±0.30	-
20	2220	5.70±0.40	5.00±0.40	≤ 3.50	0.60±0.30	-

**Part Numbering**

MCF	05	K	T	B	500	105	A
Product Type	Dimensions (L×W)	Capacitance Tolerance	Packaging Code	Dielectric	Voltage (VDCW)	Capacitance	Function Code
MCFA:Flexible Termination MCF:Barrier Termination	01: 0201 02: 0402 03: 0603 05: 0805 06: 1206 10: 1210 08: 1808 12: 1812 20: 2220	A: ±0.05pF (Cap≤10pF) B: ±0.1pF (Cap≤10pF) C: ±0.25pF (Cap≤10pF) D: ±0.5pF (Cap≤10pF) F: ±1% G: ±2% J: ±5% K: ±10% M: ±20%	T: Taping Reel	N: NPO(COG) B: X7R BS: X7S X: X5R	6V3: 6.3V 100: 10V 160: 16V 250: 25V 500: 50V 101: 100V 251: 250V 501: 500V 631: 630V	0R1: 0.1pF 1R0: 1pF 100: 10pF 101: 100pF 102: 1nF 103: 10nF 104: 100nF 105: 1uF 106: 10uF 107: 100uF	A: Automotive Grade

**General Capacitance & Voltage for MCFA..A Series**

Capacitance & Voltage(X7R)

Dielectric		X7R											
EIA	Size	0402						0603					
Code	VDCW	6.3V	10V	16V	25V	50V	100V	6.3V	10V	16V	25V	50V	100V
121	120pF	0.5	0.5	0.5	0.5	0.5	0.5	0.8	0.8	0.8	0.8	0.8	0.8
151	150	0.5	0.5	0.5	0.5	0.5	0.5	0.8	0.8	0.8	0.8	0.8	0.8
181	180	0.5	0.5	0.5	0.5	0.5	0.5	0.8	0.8	0.8	0.8	0.8	0.8
221	220	0.5	0.5	0.5	0.5	0.5	0.5	0.8	0.8	0.8	0.8	0.8	0.8
271	270	0.5	0.5	0.5	0.5	0.5	0.5	0.8	0.8	0.8	0.8	0.8	0.8
331	330	0.5	0.5	0.5	0.5	0.5	0.5	0.8	0.8	0.8	0.8	0.8	0.8
391	390	0.5	0.5	0.5	0.5	0.5	0.5	0.8	0.8	0.8	0.8	0.8	0.8
471	470	0.5	0.5	0.5	0.5	0.5	0.5	0.8	0.8	0.8	0.8	0.8	0.8
561	560	0.5	0.5	0.5	0.5	0.5	0.5	0.8	0.8	0.8	0.8	0.8	0.8
681	680	0.5	0.5	0.5	0.5	0.5	0.5	0.8	0.8	0.8	0.8	0.8	0.8
102	1nF	0.5	0.5	0.5	0.5	0.5	0.5	0.8	0.8	0.8	0.8	0.8	0.8
122	1.2	0.5	0.5	0.5	0.5	0.5	0.5	0.8	0.8	0.8	0.8	0.8	0.8
152	1.5	0.5	0.5	0.5	0.5	0.5	0.5	0.8	0.8	0.8	0.8	0.8	0.8
182	1.8	0.5	0.5	0.5	0.5	0.5	0.5	0.8	0.8	0.8	0.8	0.8	0.8
222	2.2	0.5	0.5	0.5	0.5	0.5	0.5	0.8	0.8	0.8	0.8	0.8	0.8
272	2.7	0.5	0.5	0.5	0.5	0.5	0.5	0.8	0.8	0.8	0.8	0.8	0.8
332	3.3	0.5	0.5	0.5	0.5	0.5	0.5	0.8	0.8	0.8	0.8	0.8	0.8
392	3.9	0.5	0.5	0.5	0.5	0.5	0.5	0.8	0.8	0.8	0.8	0.8	0.8
472	4.7	0.5	0.5	0.5	0.5	0.5	0.5	0.8	0.8	0.8	0.8	0.8	0.8
562	5.6	0.5	0.5	0.5	0.5	0.5	0.5	0.8	0.8	0.8	0.8	0.8	0.8
682	6.8	0.5	0.5	0.5	0.5	0.5	0.5	0.8	0.8	0.8	0.8	0.8	0.8
103	10nF	0.5	0.5	0.5	0.5	0.5		0.8	0.8	0.8	0.8	0.8	0.8
123	12	0.5	0.5	0.5	0.5	0.5		0.8	0.8	0.8	0.8	0.8	0.8
153	15	0.5	0.5	0.5	0.5	0.5		0.8	0.8	0.8	0.8	0.8	0.8
183	18	0.5	0.5	0.5	0.5	0.5		0.8	0.8	0.8	0.8	0.8	0.8
223	22	0.5	0.5	0.5	0.5	0.5		0.8	0.8	0.8	0.8	0.8	0.8
273	27	0.5	0.5	0.5	0.5	0.5		0.8	0.8	0.8	0.8	0.8	0.8
333	33	0.5	0.5	0.5	0.5	0.5		0.8	0.8	0.8	0.8	0.8	0.8
393	39	0.5	0.5	0.5	0.5	0.5		0.8	0.8	0.8	0.8	0.8	0.8
473	47	0.5	0.5	0.5	0.5	0.5		0.8	0.8	0.8	0.8	0.8	0.8
563	56							0.8	0.8	0.8	0.8	0.8	0.8
683	68							0.8	0.8	0.8	0.8	0.8	0.8

List of capacity and thickness of class II capacitors with specific voltage. Unit: mm

**■ General Capacitance & Voltage for MCFA..A Series**

Capacitance & Voltage(X7R)

Dielectric		X7R												
EIA	Size	0805							1206					
Code	VDCW	≤10V	16V	25V	50V	100V	250V	500V	≤25V	50V	100V	250V	500V	1000V
121	120pF	0.8	0.8	0.8	0.8	0.8	0.8	0.8	0.8	0.8	0.8	0.8	0.8	0.8
151	150	0.8	0.8	0.8	0.8	0.8	0.8	0.8	0.8	0.8	0.8	0.8	0.8	0.8
181	180	0.8	0.8	0.8	0.8	0.8	0.8	0.8	0.8	0.8	0.8	0.8	0.8	0.8
221	220	0.8	0.8	0.8	0.8	0.8	0.8	0.8	0.8	0.8	0.8	0.8	0.8	0.8
271	270	0.8	0.8	0.8	0.8	0.8	0.8	0.8	0.8	0.8	0.8	0.8	0.8	0.8
331	330	0.8	0.8	0.8	0.8	0.8	0.8	0.8	0.8	0.8	0.8	0.8	0.8	0.8
391	390	0.8	0.8	0.8	0.8	0.8	0.8	0.8	0.8	0.8	0.8	0.8	0.8	0.8
471	470	0.8	0.8	0.8	0.8	0.8	0.8	0.8	0.8	0.8	0.8	0.8	0.8	0.8
561	560	0.8	0.8	0.8	0.8	0.8	0.8	0.8	0.8	0.8	0.8	0.8	0.8	0.8
681	680	0.8	0.8	0.8	0.8	0.8	0.8	0.8	0.8	0.8	0.8	0.8	0.8	0.8
102	1nF	0.8	0.8	0.8	0.8	0.8	0.8	0.8	0.8	0.8	0.8	0.8	0.8	0.8
122	1.2	0.8	0.8	0.8	0.8	0.8	0.8	0.8	0.8	0.8	0.8	0.8	0.8	0.8
152	1.5	0.8	0.8	0.8	0.8	0.8	0.8	0.8	0.8	0.8	0.8	0.8	0.8	0.8
182	1.8	0.8	0.8	0.8	0.8	0.8	0.8	0.8	0.8	0.8	0.8	0.8	0.8	0.8
222	2.2	0.8	0.8	0.8	0.8	0.8	0.8	0.8	0.8	0.8	0.8	0.8	0.8	0.8
272	2.7	0.8	0.8	0.8	0.8	0.8	0.8	0.8	0.8	0.8	0.8	0.8	0.8	0.8
332	3.3	0.8	0.8	0.8	0.8	0.8	0.8	0.8	0.8	0.8	0.8	0.8	0.8	0.8
392	3.9	0.8	0.8	0.8	0.8	0.8	0.8	0.8	0.8	0.8	0.8	0.8	0.8	0.8
472	4.7	0.8	0.8	0.8	0.8	0.8	0.8	0.8	0.8	0.8	0.8	0.8	0.8	0.8
562	5.6	0.8	0.8	0.8	0.8	0.8	0.8	0.8	0.8	0.8	0.8	0.8	0.8	0.8
682	6.8	0.8	0.8	0.8	0.8	0.8	0.8	0.8	0.8	0.8	0.8	0.8	0.8	0.8
103	10nF	0.8	0.8	0.8	0.8	0.8	0.8	0.8	0.8	0.8	0.8	0.8	0.8	0.8
123	12	0.8	0.8	0.8	0.8	0.8	0.8	0.8	0.8	0.8	0.8	0.8	0.8	0.8
153	15	0.8	0.8	0.8	0.8	0.8	0.8	0.8	0.8	0.8	0.8	0.8	0.8	0.8
183	18	0.8	0.8	0.8	0.8	0.8	0.8	0.8	0.8	0.8	0.8	0.8	0.8	0.8
223	22	0.8	0.8	0.8	0.8	0.8	0.8	0.8	0.8	0.8	0.8	0.8	0.8	0.8
273	27	0.8	0.8	0.8	0.8	0.8	0.8	0.8	0.8	0.8	0.8	0.8	0.8	0.8
333	33	0.8	0.8	0.8	0.8	0.8	0.8	0.8	0.8	0.8	0.8	0.8	0.8	0.8
393	39	0.8	0.8	0.8	0.8	0.8	0.8	0.8	0.8	0.8	0.8	0.8	0.8	0.8
473	47	0.8	0.8	0.8	0.8	0.8	0.8	0.8	0.8	0.8	0.8	0.8	0.8	0.8
563	56	0.8	0.8	0.8	0.8	0.8	0.8	0.8	0.8	0.8	0.8	0.8	0.8	0.8
683	68	0.8	0.8	0.8	0.8	0.8	0.8	0.8	0.8	0.8	0.8	0.8	0.8	0.8
104	100nF	0.8	0.8	0.8	0.8	0.8	0.8	0.8	0.8	0.8	0.8	0.8	0.8	0.8

■ List of capacity and thickness of class II capacitors with specific voltage. Unit: mm

Capacitance & Voltage(X5R)

Dielectric		X5R														
EIA	Size	0402				0603					0805					
Code	VDCW	6.3V	10V	16V	25V	6.3V	10V	16V	25V	50V	6.3V	10V	16V	25V	50V	100V
473	47nF					0.8	0.8	0.8	0.8	0.8						
563	56	0.5	0.5	0.5	0.5						0.8	0.8	0.8	0.8	0.8	0.8
683	68	0.5	0.5	0.5	0.5						0.8	0.8	0.8	0.8	0.8	0.8
104	100nF	0.5	0.5	0.5	0.5						0.8	0.8	0.8	0.8	0.8	0.8

■ List of capacity and thickness of class II capacitors with specific voltage. Unit: mm

Capacitance & Voltage(X7S)

Dielectric		X7S												
EIA	Size	0402				0603					0805			
Code	VDCW	6.3V	10V	16V	25V	6.3V	10V	16V	25V	50V	≤10V	16V	25V	
393	39nF	0.5	0.5	0.5	0.5									
473	47	0.5	0.5	0.5	0.5	0.8	0.8	0.8	0.8	0.8				
563	56	0.5	0.5	0.5	0.5	0.8	0.8	0.8	0.8	0.8	0.8	0.8	0.8	
683	68	0.5	0.5	0.5	0.5	0.8	0.8	0.8	0.8	0.8	0.8	0.8	0.8	
104	100nF	0.5	0.5	0.5	0.5						0.8	0.8	0.8	

■ List of capacity and thickness of class II capacitors with specific voltage. Unit: mm

**■ General Capacitance & Voltage for MCF..A Series**

Capacitance & Voltage(NPO)

Dielectric		NPO																	
EIA	Size	0201			0402		0603			0805				1206					
Code	VDCW	25V 50V	50V	100V	50V	100V	250V	50V	100V	250V	500V	50V	100V	250V	500V	1000V	2000V		
0R1	0.1pF	0.3	0.5	0.5	0.8	0.8	0.8												
0R2	0.2	0.3	0.5	0.5	0.8	0.8	0.8												
0R5	0.5	0.3	0.5	0.5	0.8	0.8	0.8	0.8	0.8	0.8	0.8	0.8	0.8	0.8	1.25	1.25			
1R0	1pF	0.3	0.5	0.5	0.8	0.8	0.8	0.8	0.8	0.8	0.8	0.8	0.8	0.8	1.25	1.25			
1R2	1.2	0.3	0.5	0.5	0.8	0.8	0.8	0.8	0.8	0.8	0.8	0.8	0.8	0.8	1.25	1.25			
1R5	1.5	0.3	0.5	0.5	0.8	0.8	0.8	0.8	0.8	0.8	0.8	0.8	0.8	0.8	1.25	1.25			
1R8	1.8	0.3	0.5	0.5	0.8	0.8	0.8	0.8	0.8	0.8	0.8	0.8	0.8	0.8	1.25	1.25			
2R0	2.0	0.3	0.5	0.5	0.8	0.8	0.8	0.8	0.8	0.8	0.8	0.8	0.8	0.8	1.25	1.25			
2R2	2.2	0.3	0.5	0.5	0.8	0.8	0.8	0.8	0.8	0.8	0.8	0.8	0.8	0.8	1.25	1.25			
2R7	2.7	0.3	0.5	0.5	0.8	0.8	0.8	0.8	0.8	0.8	0.8	0.8	0.8	0.8	1.25	1.25	1.60		
3R0	3.0	0.3	0.5	0.5	0.8	0.8	0.8	0.8	0.8	0.8	0.8	0.8	0.8	0.8	1.25	1.25	1.60		
3R3	3.3	0.3	0.5	0.5	0.8	0.8	0.8	0.8	0.8	0.8	0.8	0.8	0.8	0.8	1.25	1.25	1.60		
3R6	3.6	0.3	0.5	0.5	0.8	0.8	0.8	0.8	0.8	0.8	0.8	0.8	0.8	0.8	1.25	1.25	1.60		
3R9	3.9	0.3	0.5	0.5	0.8	0.8	0.8	0.8	0.8	0.8	0.8	0.8	0.8	0.8	1.25	1.25	1.60		
4R7	4.7	0.3	0.5	0.5	0.8	0.8	0.8	0.8	0.8	0.8	0.8	0.8	0.8	0.8	1.25	1.25	1.60		
5R0	5.0	0.3	0.5	0.5	0.8	0.8	0.8	0.8	0.8	0.8	0.8	0.8	0.8	0.8	1.25	1.25	1.60		
5R6	5.6	0.3	0.5	0.5	0.8	0.8	0.8	0.8	0.8	0.8	0.8	0.8	0.8	0.8	1.25	1.25	1.60		
6R8	6.8	0.3	0.5	0.5	0.8	0.8	0.8	0.8	0.8	0.8	0.8	0.8	0.8	0.8	1.25	1.25	1.60		
8R0	8.0	0.3	0.5	0.5	0.8	0.8	0.8	0.8	0.8	0.8	0.8	0.8	0.8	0.8	1.25	1.25	1.60		
8R2	8.2	0.3	0.5	0.5	0.8	0.8	0.8	0.8	0.8	0.8	0.8	0.8	0.8	0.8	1.25	1.25	1.60		
100	10pF	0.3	0.5	0.5	0.8	0.8	0.8	0.8	0.8	0.8	0.8	0.8	0.8	0.8	1.25	1.25	1.60		
120	12	0.3	0.5	0.5	0.8	0.8	0.8	0.8	0.8	0.8	0.8	0.8	0.8	0.8	1.25	1.25	1.60		
150	15	0.3	0.5	0.5	0.8	0.8	0.8	0.8	0.8	0.8	0.8	0.8	0.8	0.8	1.25	1.25	1.60		
180	18	0.3	0.5	0.5	0.8	0.8	0.8	0.8	0.8	0.8	0.8	0.8	0.8	0.8	1.25	1.25	1.60		
220	22	0.3	0.5	0.5	0.8	0.8	0.8	0.8	0.8	0.8	0.8	0.8	0.8	0.8	1.25	1.25	1.60		
270	27	0.3	0.5	0.5	0.8	0.8	0.8	0.8	0.8	0.8	0.8	0.8	0.8	0.8	1.25	1.25	1.60		
330	33	0.3	0.5	0.5	0.8	0.8	0.8	0.8	0.8	0.8	0.8	0.8	0.8	0.8	1.25	1.25	1.60		
390	39	0.3	0.5	0.5	0.8	0.8	0.8	0.8	0.8	0.8	0.8	0.8	0.8	0.8	1.25	1.25	1.60		
470	47	0.3	0.5	0.5	0.8	0.8	0.8	0.8	0.8	0.8	0.8	0.8	0.8	0.8	1.25	1.25	1.60		
560	56	0.3	0.5	0.5	0.8	0.8	0.8	0.8	0.8	0.8	0.8	0.8	0.8	0.8	1.25	1.25	1.60		
680	68	0.3	0.5	0.5	0.8	0.8	0.8	0.8	0.8	0.8	0.8	0.8	0.8	0.8	1.25	1.25	1.60		
101	100pF	0.3	0.5	0.5	0.8	0.8	0.8	0.8	0.8	0.8	0.8	0.8	0.8	0.8	1.25	1.25	1.60		
121	120		0.5		0.8	0.8	0.8	0.8	0.8	0.8	0.8	0.8	0.8	0.8	1.25	1.25	1.60		
151	150		0.5		0.8	0.8	0.8	0.8	0.8	0.8	1.25	0.8	0.8	0.8	1.25	1.25	1.60		
181	180		0.5		0.8	0.8	0.8	0.8	0.8	0.8	1.25	0.8	0.8	0.8	1.25	1.25	1.60		
221	220		0.5		0.8	0.8	0.8	0.8	0.8	0.8	1.25	0.8	0.8	0.8	1.25	1.25	1.60		
271	270		0.5		0.8	0.8	0.8	0.8	0.8	0.8	1.25	0.8	0.8	0.8	1.25	1.25			
331	330		0.5		0.8	0.8	0.8	0.8	0.8	0.8	1.25	0.8	0.8	0.8	1.25	1.25			
391	390		0.5		0.8	0.8		0.8	0.8	0.8		0.8	0.8	0.8	1.25	1.25			
471	470		0.5		0.8	0.8		0.8	0.8	0.8		0.8	0.8	0.8	1.25	1.25			
561	560		0.5		0.8	0.8		0.8	0.8	0.8		0.8	0.8	0.8	1.25	1.60			
681	680		0.5		0.8	0.8		0.8	0.8	0.8		0.8	0.8	0.8	1.25	1.60			
102	1nF		0.5		0.8	0.8		0.8	0.8	0.8		0.8	0.8	0.8	1.60				
152	1.5				0.8			0.8				1.25	1.25	1.25					
182	1.8				0.8			0.8				1.25	1.25	1.25					
222	2.2				0.8			0.8				1.25	1.25	1.25					
272	2.7							0.8				1.25							
332	3.3							0.8				1.25							
472	4.7											1.25							

■ List of capacity and thickness of class I capacitors with specific voltage. Unit: mm

**■ General Capacitance & Voltage for MCF..A Series**

Capacitance & Voltage(NPO)

Dielectric		NPO								
EIA	Size	1210				1808				
Code	VDCW	250V	500V	1000V	2000V	250V	500V	1000V	2000V	3000V
1R0	1pF	1.25	1.25	1.25	1.6	1.6	1.6	1.6		
1R2	1.2	1.25	1.25	1.25	1.6	1.6	1.6	1.6		
1R5	1.5	1.25	1.25	1.25	1.6	1.6	1.6	1.6		
1R8	1.8	1.25	1.25	1.25	1.6	1.6	1.6	1.6		
2R0	2.0	1.25	1.25	1.25	1.6	1.6	1.6	1.6		
2R2	2.2	1.25	1.25	1.25	1.6	1.6	1.6	1.6		
2R7	2.7	1.25	1.25	1.25	1.6	1.6	1.6	1.6	1.6	1.6
3R0	3.0	1.25	1.25	1.25	1.6	1.6	1.6	1.6	1.6	1.6
3R3	3.3	1.25	1.25	1.25	1.6	1.6	1.6	1.6	1.6	1.6
3R6	3.6	1.25	1.25	1.25	1.6	1.6	1.6	1.6	1.6	1.6
3R9	3.9	1.25	1.25	1.25	1.6	1.6	1.6	1.6	1.6	1.6
4R7	4.7	1.25	1.25	1.25	1.6	1.6	1.6	1.6	1.6	1.6
5R0	5.0	1.25	1.25	1.25	1.6	1.6	1.6	1.6	1.6	1.6
5R6	5.6	1.25	1.25	1.25	1.6	1.6	1.6	1.6	1.6	1.6
6R8	6.8	1.25	1.25	1.25	1.6	1.6	1.6	1.6	1.6	1.6
8R0	8.0	1.25	1.25	1.25	1.6	1.6	1.6	1.6	1.6	1.6
8R2	8.2	1.25	1.25	1.25	1.6	1.6	1.6	1.6	1.6	1.6
100	10pF	1.25	1.25	1.25	1.6	1.6	1.6	1.6	1.6	1.6
120	12	1.25	1.25	1.25	1.6	1.6	1.6	1.6	1.6	1.6
150	15	1.25	1.25	1.25	1.6	1.6	1.6	1.6	1.6	1.6
180	18	1.25	1.25	1.25	1.6	1.6	1.6	1.6	1.6	1.6
220	22	1.25	1.25	1.25	1.6	1.6	1.6	1.6	1.6	1.6
270	27	1.25	1.25	1.25	1.6	1.6	1.6	1.6	1.6	1.6
330	33	1.25	1.25	1.25	1.6	1.6	1.6	1.6	1.6	1.6
390	39	1.25	1.25	1.25	1.6	1.6	1.6	1.6	1.6	1.6
470	47	1.25	1.25	1.25	1.6	1.6	1.6	1.6	1.6	1.6
560	56	1.25	1.25	1.25	1.6	1.6	1.6	1.6	1.6	1.6
680	68	1.25	1.25	1.25	1.6	1.6	1.6	1.6	1.6	1.6
101	100pF	1.25	1.25	1.25	1.6	1.6	1.6	1.6	1.6	1.6
121	120	1.25	1.25	1.25	1.6	1.6	1.6	1.6	1.6	1.6
151	150	1.25	1.25	1.25	1.6	1.6	1.6	1.6	1.6	1.6
181	180	1.25	1.25	1.25	1.6	1.6	1.6	1.6	1.6	1.6
221	220	1.25	1.25	1.6	1.6	1.6	1.6	1.6	1.6	1.6
271	270	1.25	1.25	1.6		1.6	1.6	1.6	1.6	
331	330	1.25	1.25	1.6		1.6	1.6	1.6		
391	390	1.25	1.25			1.6	1.6	1.6		
471	470	1.25	1.25			1.6	1.6	1.6		
561	560	1.25	1.25			1.6	1.6	1.6		
681	680	1.25	1.25			1.6	1.6	1.6		
102	1nF	1.25	1.6			1.6	1.6			
152	1.5	1.25	1.6			1.6	1.6			
182	1.8	1.25	2.0			1.6				
222	2.2	1.6				1.6				
272	2.7	1.6				1.6				
332	3.3	1.6				1.6				
392	3.9					1.6				

■ List of capacity and thickness of class I capacitors with specific voltage. Unit: mm

**■ General Capacitance & Voltage for MCF..A Series**

Capacitance & Voltage(NPO)

Dielectric		NPO									
EIA	Size	1812					2220				
Code	VDCW	250V	500V	1000V	2000V	3000V	250V	630V	1000V	2000V	3000V
1R0	1pF	1.6	1.6	1.6	1.6	1.6	1.6	1.6	1.6		
1R2	1.2	1.6	1.6	1.6	1.6	1.6	1.6	1.6	1.6		
1R5	1.5	1.6	1.6	1.6	1.6	1.6	1.6	1.6	1.6		
1R8	1.8	1.6	1.6	1.6	1.6	1.6	1.6	1.6	1.6		
2R0	2.0	1.6	1.6	1.6	1.6	1.6	1.6	1.6	1.6		
2R2	2.2	1.6	1.6	1.6	1.6	1.6	1.6	1.6	1.6		
2R7	2.7	1.6	1.6	1.6	1.6	1.6	1.6	1.6	1.6		
3R0	3.0	1.6	1.6	1.6	1.6	1.6	1.6	1.6	1.6		
3R3	3.3	1.6	1.6	1.6	1.6	1.6	1.6	1.6	1.6		
3R6	3.6	1.6	1.6	1.6	1.6	1.6	1.6	1.6	1.6		
3R9	3.9	1.6	1.6	1.6	1.6	1.6	1.6	1.6	1.6		
4R7	4.7	1.6	1.6	1.6	1.6	1.6	1.6	1.6	1.6		
5R0	5.0	1.6	1.6	1.6	1.6	1.6	1.6	1.6	1.6		
5R6	5.6	1.6	1.6	1.6	1.6	1.6	1.6	1.6	1.6		
6R8	6.8	1.6	1.6	1.6	1.6	1.6	1.6	1.6	1.6		
8R0	8.0	1.6	1.6	1.6	1.6	1.6	1.6	1.6	1.6		
8R2	8.2	1.6	1.6	1.6	1.6	1.6	1.6	1.6	1.6		
100	10pF	1.6	1.6	1.6	1.6	1.6	1.6	1.6	1.6	2.0	2.0
120	12	1.6	1.6	1.6	1.6	1.6	1.6	1.6	1.6	2.0	2.0
150	15	1.6	1.6	1.6	1.6	1.6	1.6	1.6	1.6	2.0	2.0
180	18	1.6	1.6	1.6	1.6	1.6	1.6	1.6	1.6	2.0	2.0
220	22	1.6	1.6	1.6	1.6	1.6	1.6	1.6	1.6	2.0	2.0
270	27	1.6	1.6	1.6	1.6	1.6	1.6	1.6	1.6	2.0	2.0
330	33	1.6	1.6	1.6	1.6	1.6	1.6	1.6	1.6	2.0	2.0
390	39	1.6	1.6	1.6	1.6	1.6	1.6	1.6	1.6	2.0	2.0
470	47	1.6	1.6	1.6	1.6	1.6	1.6	1.6	1.6	2.0	2.0
560	56	1.6	1.6	1.6	1.6	1.6	1.6	1.6	1.6	2.0	2.0
680	68	1.6	1.6	1.6	1.6	1.6	1.6	1.6	1.6	2.0	2.0
101	100pF	1.6	1.6	1.6	1.6	1.6	1.6	1.6	1.6	2.0	2.0
121	120	1.6	1.6	1.6	1.6	1.6	1.6	1.6	1.6	2.0	2.0
151	150	1.6	1.6	1.6	1.6	1.6	1.6	1.6	1.6	2.0	2.0
181	180	1.6	1.6	1.6	1.6	2.0	1.6	1.6	1.6	2.0	2.0
221	220	1.6	1.6	1.6	1.6	2.0	1.6	1.6	1.6	2.0	2.0
271	270	1.6	1.6	1.6	1.6	2.0	1.6	1.6	1.6	2.0	2.0
331	330	1.6	1.6	1.6	1.6	2.0	1.6	1.6	1.6	2.0	2.0
391	390	1.6	1.6	1.6	1.6		1.6	1.6	1.6	2.0	2.0
471	470	1.6	1.6	1.6	1.6		1.6	1.6	1.6	2.0	2.0
561	560	1.6	1.6	1.6	2.0		1.6	1.6	1.6	2.0	2.0
681	680	1.6	1.6	1.6	2.0		1.6	1.6	1.6	2.0	2.0
102	1nF	1.6	1.6	2.0			1.6	1.6	1.6	2.0	2.0
152	1.5	1.6	1.6				1.6	1.6	2.0		
182	1.8	1.6	1.6				1.6	1.6	2.0		
222	2.2	1.6	1.6				1.6	1.6			
272	2.7	1.6	2.0				1.6	1.6			
332	3.3	1.6	2.0				1.6	1.6			
392	3.9	1.6	2.0				1.6	1.6			
472	4.7	1.6	2.0				1.6	1.6			
562	5.6	1.6					1.6	1.6			
682	6.8	1.6					1.6	1.6			
103	10nF						1.6				
153	15						1.6				

■ List of capacity and thickness of class I capacitors with specific voltage. Unit: mm

**■ General Capacitance & Voltage for MCF..A Series**

Capacitance & Voltage(X7R)

Dielectric		X7R							
EIA	Size	0201		0603					
Code	VDCW	≤25V	50V	6.3V	10V	16V	25V	50V	100V
121	120pF	0.3	0.3						
151	150	0.3	0.3						
181	180	0.3	0.3						
221	220	0.3	0.3						
271	270	0.3	0.3						
331	330	0.3	0.3						
391	390	0.3	0.3						
471	470	0.3	0.3						
561	560	0.3	0.3						
681	680	0.3	0.3						
102	1nF	0.3	0.3						
122	1.2	0.3	0.3						
152	1.5	0.3	0.3						
182	1.8	0.3	0.3						
222	2.2	0.3	0.3						
272	2.7	0.3	0.3						
332	3.3	0.3	0.3						
392	3.9	0.3	0.3						
472	4.7	0.3	0.3						
562	5.6	0.3							
682	6.8	0.3							
103	10nF	0.3							
104	100nF			0.8	0.8	0.8	0.8	0.8	0.8
224	220			0.8	0.8	0.8	0.8	0.8	0.8

■ List of capacity and thickness of class II capacitors with specific voltage. Unit: mm

Dielectric		X7R						
EIA	Size	0805						
Code	VDCW	≤10V	16V	25V	50V	100V	250V	500V
332	3.3nF							1.25
392	39.							1.25
472	4.7							1.25
562	5.6						1.25	1.25
682	6.8						1.25	1.25
103	10nF						1.25	1.25
123	12						1.25	
153	15						1.25	
183	18						1.25	
223	22						1.25	
273	27						1.25	
333	33						1.25	
683	68					1.25		
104	100nF					1.25		
224	220	0.8	0.8	0.8	0.8	1.25		
334	330	0.8	0.8	0.8	0.8			
474	470	1.25	1.25	1.25	1.25			
684	680	1.25	1.25	1.25	1.25			
105	1uF	1.25						
475	4.7			1.25				



**■ General Capacitance & Voltage for MCF..A Series**

Capacitance & Voltage(X7R)

Dielectric		X7R												
EIA	Size	1206								1210				
Code	VDCW	≤25V	50V	100V	250V	500V	1000V	2000V	≤50V	100V	250V	500V	1000V	2000V
121	120pF								1.25	1.25	1.25	1.25	1.25	1.25
151	150								1.25	1.25	1.25	1.25	1.25	1.25
181	180								1.25	1.25	1.25	1.25	1.25	1.25
221	220								1.25	1.25	1.25	1.25	1.25	1.25
271	270								1.25	1.25	1.25	1.25	1.25	1.25
331	330								1.25	1.25	1.25	1.25	1.25	1.25
391	390								1.25	1.25	1.25	1.25	1.25	1.25
471	470								1.25	1.25	1.25	1.25	1.25	1.25
561	560								1.25	1.25	1.25	1.25	1.25	1.25
681	680								1.25	1.25	1.25	1.25	1.25	1.25
102	1nF								1.25	1.25	1.25	1.25	1.25	1.25
122	1.2							1.25	1.25	1.25	1.25	1.25	1.25	1.25
152	1.5							1.25	1.25	1.25	1.25	1.25	1.25	1.25
182	1.8							1.25	1.25	1.25	1.25	1.25	1.25	1.25
222	2.2							1.25	1.25	1.25	1.25	1.25	1.25	1.25
272	2.7							1.25	1.25	1.25	1.25	1.25	1.25	1.25
332	3.3							1.25	1.25	1.25	1.25	1.25	1.25	1.25
392	3.9							1.25	1.25	1.25	1.25	1.25	1.25	1.25
472	4.7							1.25	1.25	1.25	1.25	1.25	1.25	1.25
562	5.6				1.25	1.25	1.25		1.25	1.25	1.25	1.25	1.25	1.6
682	6.8				1.25	1.25	1.25		1.25	1.25	1.25	1.25	1.6	1.6
103	10nF				1.25	1.25	1.25		1.25	1.25	1.25	1.25	1.6	2.0
123	12				1.25	1.25			1.25	1.25	1.25	1.25	1.6	
153	15				1.25	1.25			1.25	1.25	1.25	1.25	1.6	
183	18				1.25	1.25			1.25	1.25	1.25	1.25	1.6	
223	22				1.25	1.25			1.25	1.25	1.25	1.25	1.6	
273	27				1.25	1.25			1.25	1.25	1.25	1.6		
333	33				1.25	1.25			1.25	1.25	1.25	1.6		
393	39				1.25				1.25	1.25	1.25	1.6		
473	47				1.25				1.25	1.25	1.25	1.6		
563	56				1.25				1.25	1.25	1.25	1.6		
683	68			1.25	1.25				1.25	1.25	1.25	1.6		
104	100nF			1.25	1.25				1.25	1.25	1.25	1.6		
224	220	0.8	0.8	1.25					1.6	1.6	1.6			
334	330	0.8	0.8	1.60					1.6	1.6				
474	470	0.8	0.8	1.60					1.6	1.6				
684	680	0.8	0.8	1.6					1.6	1.6				
105	1uF	0.8	1.6	1.6					1.6	1.6				
225	2.2	1.6	1.6						1.6					
335	3.3	1.6							1.6					
475	4.7	1.6							1.6					

■ List of capacity and thickness of class I capacitors with specific voltage. Unit: mm

**General Capacitance & Voltage for MCF..A Series**

Capacitance & Voltage(X7R)

Dielectric		X7R									
EIA	Size	1808					1812				
Code	VDCW	≤250V	500V	1000V	2000V	3000V	≤250V	500V	1000V	2000V	3000V
121	120pF	1.6	1.6	1.6	1.6	1.6	1.6	1.6	1.6	1.6	1.6
151	150	1.6	1.6	1.6	1.6	1.6	1.6	1.6	1.6	1.6	1.6
181	180	1.6	1.6	1.6	1.6	1.6	1.6	1.6	1.6	1.6	1.6
221	220	1.6	1.6	1.6	1.6	1.6	1.6	1.6	1.6	1.6	1.6
271	270	1.6	1.6	1.6	1.6	1.6	1.6	1.6	1.6	1.6	1.6
331	330	1.6	1.6	1.6	1.6	1.6	1.6	1.6	1.6	1.6	1.6
391	390	1.6	1.6	1.6	1.6	1.6	1.6	1.6	1.6	1.6	1.6
471	470	1.6	1.6	1.6	1.6	1.6	1.6	1.6	1.6	1.6	1.6
561	560	1.6	1.6	1.6	1.6	1.6	1.6	1.6	1.6	1.6	1.6
681	680	1.6	1.6	1.6	1.6	1.6	1.6	1.6	1.6	1.6	1.6
102	1nF	1.6	1.6	1.6	1.6	1.6	1.6	1.6	1.6	1.6	1.6
122	1.2	1.6	1.6	1.6	1.6	1.6	1.6	1.6	1.6	1.6	1.6
152	1.5	1.6	1.6	1.6	1.6	1.6	1.6	1.6	1.6	1.6	1.6
182	1.8	1.6	1.6	1.6	1.6	1.6	1.6	1.6	1.6	1.6	1.6
222	2.2	1.6	1.6	1.6	1.6	1.6	1.6	1.6	1.6	1.6	1.6
272	2.7	1.6	1.6	1.6	1.6	1.6	1.6	1.6	1.6	1.6	1.6
332	3.3	1.6	1.6	1.6	1.6	1.6	1.6	1.6	1.6	1.6	1.6
392	3.9	1.6	1.6	1.6	1.6	1.6	1.6	1.6	1.6	1.6	1.6
472	4.7	1.6	1.6	1.6	1.6	1.6	1.6	1.6	1.6	1.6	1.6
562	5.6	1.6	1.6	1.6	1.6		1.6	1.6	1.6	1.6	
682	6.8	1.6	1.6	1.6	1.6		1.6	1.6	1.6	1.6	
103	10nF	1.6	1.6	1.6	1.6		1.6	1.6	1.6	1.6	
123	12	1.6	1.6	1.6			1.6	1.6	1.6	1.6	
153	15	1.6	1.6	1.6			1.6	1.6	1.6		
183	18	1.6	1.6	1.6			1.6	1.6	1.6		
223	22	1.6	1.6	1.6			1.6	1.6	1.6		
273	27	1.6	1.6	1.6			1.6	1.6	1.6		
333	33	1.6	1.6	2.0			1.6	1.6	1.6		
393	39	1.6	1.6				1.6	1.6	1.6		
473	47	1.6	1.6				1.6	1.6	1.6		
563	56	1.6	2.5				1.6	1.6	2.0		
683	68	1.6	2.5				1.6	1.6			
104	100nF	1.6					1.6	2.5			
224	220	2.0					1.6				
334	330	2.0					2.0				
474	470	2.0					2.0				
684	680	2.0					2.0				
105	1uF						2.0				

List of capacity and thickness of class I capacitors with specific voltage. Unit: mm

**■ General Capacitance & Voltage for MCF..A Series**

Capacitance & Voltage(X7R)

Dielectric		X7R				
EIA	Size	2220				
Code	VDCW	250V	500V	1000V	2000V	3000V
102	1nF	1.6	1.6	1.6	1.6	1.6
122	1.2	1.6	1.6	1.6	1.6	1.6
152	1.5	1.6	1.6	1.6	1.6	1.6
182	1.8	1.6	1.6	1.6	1.6	1.6
222	2.2	1.6	1.6	1.6	1.6	1.6
272	2.7	1.6	1.6	1.6	1.6	1.6
332	3.3	1.6	1.6	1.6	1.6	1.6
392	3.9	1.6	1.6	1.6	1.6	1.6
472	4.7	1.6	1.6	1.6	1.6	1.6
562	5.6	1.6	1.6	1.6	1.6	1.6
682	6.8	1.6	1.6	1.6	1.6	1.6
103	10nF	1.6	1.6	1.6	1.6	1.6
123	12	1.6	1.6	1.6	1.6	
153	15	1.6	1.6	1.6	1.6	
183	18	1.6	1.6	1.6	1.6	
223	22	1.6	1.6	1.6	1.6	
273	27	1.6	1.6	1.6	1.8	
333	33	1.6	1.6	1.6	1.8	
393	39	1.6	1.6	1.6	1.8	
473	47	1.6	1.6	1.6	2.0	
563	56	1.6	1.6	1.6		
683	68	1.6	1.6	1.6		
104	100nF	1.6	1.6	2.0		
224	220	1.6	1.6			
334	330	1.6	1.6			
474	470	1.6	2.0			
684	680	2.0				
105	1uF	2.0				

■ List of capacity and thickness of class I capacitors with specific voltage. Unit: mm

**■ General Capacitance & Voltage for MCF..A Series**

Capacitance & Voltage(X7S)

Dielectric		X7S													
EIA	Size	0201				0402		0603					0805		
Code	VDCW	≤10V	16V	25V	50V	6.3V	10V	6.3V	10V	16V	25V	50V	≤10V	16V	25V
121	120pF	0.3	0.3	0.3	0.3										
151	150	0.3	0.3	0.3	0.3										
181	180	0.3	0.3	0.3	0.3										
221	220	0.3	0.3	0.3	0.3										
271	270	0.3	0.3	0.3	0.3										
331	330	0.3	0.3	0.3	0.3										
391	390	0.3	0.3	0.3	0.3										
471	470	0.3	0.3	0.3	0.3										
561	560	0.3	0.3	0.3	0.3										
681	680	0.3	0.3	0.3	0.3										
102	1nF	0.3	0.3	0.3	0.3										
122	1.2	0.3	0.3	0.3	0.3										
152	1.5	0.3	0.3	0.3	0.3										
182	1.8	0.3	0.3	0.3	0.3										
222	2.2	0.3	0.3	0.3	0.3										
272	2.7	0.3	0.3	0.3	0.3										
332	3.3	0.3	0.3	0.3	0.3										
392	3.9	0.3	0.3	0.3	0.3										
472	4.7	0.3	0.3	0.3	0.3										
562	5.6	0.3	0.3	0.3											
682	6.8	0.3	0.3	0.3											
103	10nF	0.3	0.3	0.3											
123	12	0.3	0.3												
153	15	0.3	0.3												
183	18	0.3	0.3												
223	22	0.3	0.3												
273	27	0.3	0.3												
333	33	0.3	0.3												
393	39	0.3													
473	47	0.3													
104	100nF							0.8	0.8	0.8	0.8	0.8			
224	220					0.5	0.5	0.8	0.8	0.8	0.8	0.8	0.8	0.8	0.8
334	330							0.8	0.8	0.8	0.8		0.8	0.8	0.8
474	470							0.8	0.8	0.8	0.8		1.25	1.25	1.25
684	680							0.8	0.8	0.8			1.25	1.25	1.25
105	1uF							0.8	0.8	0.8			1.25	1.25	1.25
225	2.2uF												1.25	1.25	1.25

■ List of capacity and thickness of class II capacitors with specific voltage. Unit: mm

**■General Capacitance & Voltage for MCF..A Series**

Capacitance & Voltage(X5R)

Dielectric		X5R												
EIA	Size	0201				0402				0603				
Code	VDCW	≤10V	16V	25V	50V	6.3V	10V	16V	25V	6.3V	10V	16V	25V	50V
121	120pF	0.3	0.3	0.3	0.3									
151	150	0.3	0.3	0.3	0.3									
181	180	0.3	0.3	0.3	0.3									
221	220	0.3	0.3	0.3	0.3									
271	270	0.3	0.3	0.3	0.3									
331	330	0.3	0.3	0.3	0.3									
391	390	0.3	0.3	0.3	0.3									
471	470	0.3	0.3	0.3	0.3									
561	560	0.3	0.3	0.3	0.3									
681	680	0.3	0.3	0.3	0.3									
102	1nF	0.3	0.3	0.3	0.3									
122	1.2	0.3	0.3	0.3	0.3									
152	1.5	0.3	0.3	0.3	0.3									
182	1.8	0.3	0.3	0.3	0.3									
222	2.2	0.3	0.3	0.3	0.3									
272	2.7	0.3	0.3	0.3	0.3									
332	3.3	0.3	0.3	0.3	0.3									
392	3.9	0.3	0.3	0.3	0.3									
472	4.7	0.3	0.3	0.3	0.3									
562	5.6	0.3	0.3	0.3										
682	6.8	0.3	0.3	0.3										
103	10nF	0.3	0.3	0.3										
123	12	0.3	0.3											
153	15	0.3	0.3											
183	18	0.3	0.3											
223	22	0.3	0.3											
273	27	0.3	0.3											
333	33	0.3	0.3											
393	39	0.3												
473	47	0.3												
563	56	0.3												
683	68	0.3												
104	100nF	0.3								0.8	0.8	0.8	0.8	0.8
224	220					0.5	0.5	0.5	0.5	0.8	0.8	0.8	0.8	0.8
334	330					0.5	0.5	0.5		0.8	0.8	0.8	0.8	0.8
474	470					0.5	0.5	0.5		0.8	0.8	0.8	0.8	0.8
684	680					0.5	0.5			0.8	0.8	0.8	0.8	0.8
105	1uF					0.5	0.5			0.8	0.8	0.8	0.8	0.8
225	2.2									0.8	0.8	0.8		
335	3.3									0.8				
475	4.7									0.8				

■List of capacity and thickness of class II capacitors with specific voltage. Unit: mm

Capacitance & Voltage(X5R)

Dielectric		X5R										
EIA	Size	0805					1206					
Code	VDCW	6.3V	10V	16V	25V	50V	100V	6.3V	10V	16V	25V	50V
563	56nF											
683	68						1.25					
104	100nF						1.25					
224	220	0.8	0.8	0.8	0.8	0.8	1.25					
334	330	0.8	0.8	0.8	0.8	0.8						
474	470	1.25	1.25	1.25	1.25	1.25						
684	680	1.25	1.25	1.25	1.25	1.25						
105	1uF	1.25	1.25	1.25	1.25	1.25						
225	2.2	1.25	1.25	1.25	1.25			1.6	1.6	1.6	1.6	1.6
335	3.3	1.25	1.25	1.25	1.25			1.6	1.6	1.6	1.6	1.6
475	4.7	1.25	1.25	1.25	1.25			1.6	1.6	1.6	1.6	1.6
685	6.8	1.25	1.25					1.6	1.6	1.6	1.6	
106	10uF	1.25	1.25					1.6	1.6	1.6	1.6	
156	15							1.6	1.6			
226	22							1.6	1.6			

■List of capacity and thickness of class II capacitors with specific voltage. Unit: mm

**Automotive Grade Multilayer Ceramic Chip Capacitor**

**Environmental Characteristics**

Item	Requirement	Test Method																																																																																																																																																		
Capacitance	Should be within the specified tolerance	Test Temperature: 25±3°C  NPO: (Class I) Cap≤1000pF 1.0±0.2Vrms, 1MHz±10% Cap>1000pF 1.0±0.2Vrms, 1KHz±10%  X7R/X7S/X5R: (Class II) Cap≤10uF 1.0±0.2Vrms, 1KHz±10% Cap>10uF 0.5±0.1Vrms, 120Hz±24Hz																																																																																																																																																		
IR	NPO: C ≤ 10nF, Ri ≥ 100000MΩ C > 10 nF, Ri·CR ≥ 1000S  X7R/X7S: C ≤ 25nF, Ri ≥ 10000MΩ C > 25 nF, Ri·CR ≥ 100S	Measuring Voltage: Rated Voltage Duration: 60±5s Test Humidity: ≤ 75% Test Temperature: 25±3°C Test Current: ≤ 50mA																																																																																																																																																		
(DF, tanδ) Dissipation Factor	NPO: DF ≤ 0.1%, Cr ≥ 30pF, 1MHz±10%, 1±0.2Vrms DF ≤ 0.15%, Cr < 30pF, 1MHz±10%, 1±0.2Vrms  X7R/X7S/X5R: <table border="1" data-bbox="280 779 916 1957"> <thead> <tr> <th>Voltage</th> <th>DF</th> <th>0201</th> <th>0402</th> <th>0603</th> <th>0805</th> <th>1206</th> </tr> </thead> <tbody> <tr> <td>≥ 100V</td> <td>≤ 5%</td> <td>-</td> <td>∞ 10nF</td> <td>∞ 100nF</td> <td>∞ 330nF</td> <td>∞ 680nF</td> </tr> <tr> <td rowspan="4">50V</td> <td>≤ 2.5%</td> <td>∞ 3.3nF</td> <td>∞ 10nF</td> <td>∞ 100nF</td> <td>∞ 330nF</td> <td>∞ 680nF</td> </tr> <tr> <td>≤ 3.5%</td> <td>∞ 10nF</td> <td>-</td> <td>-</td> <td>-</td> <td>∞ 1uF</td> </tr> <tr> <td>≤ 5%</td> <td>-</td> <td>-</td> <td>-</td> <td>∞ 680nF</td> <td>-</td> </tr> <tr> <td>≤ 10%</td> <td>-</td> <td>∞ 1uF</td> <td>∞ 2.2uF</td> <td>∞ 4.7uF</td> <td>∞ 10uF</td> </tr> <tr> <td rowspan="4">25V</td> <td>≤ 2.5%</td> <td>∞ 3.3nF</td> <td>∞ 10nF</td> <td>∞ 100nF</td> <td>∞ 330nF</td> <td>∞ 680nF</td> </tr> <tr> <td>≤ 3.5%</td> <td>∞ 10nF</td> <td>∞ 100nF</td> <td>∞ 330nF</td> <td>-</td> <td>∞ 2.2uF</td> </tr> <tr> <td>≤ 5%</td> <td>-</td> <td>-</td> <td>-</td> <td>∞ 1uF</td> <td>-</td> </tr> <tr> <td>≤ 7.5%</td> <td>-</td> <td>-</td> <td>-</td> <td>∞ 2.2uF</td> <td>∞ 4.7uF</td> </tr> <tr> <td rowspan="4">16V</td> <td>≤ 2.5%</td> <td>∞ 3.3nF</td> <td>∞ 10nF</td> <td>∞ 100nF</td> <td>∞ 330nF</td> <td>∞ 680nF</td> </tr> <tr> <td>≤ 3.5%</td> <td>∞ 15nF</td> <td>∞ 100nF</td> <td>∞ 330nF</td> <td>-</td> <td>∞ 22uF</td> </tr> <tr> <td>≤ 5%</td> <td>∞ 47nF</td> <td>∞ 220nF</td> <td>∞ 680nF</td> <td>∞ 22uF</td> <td>-</td> </tr> <tr> <td>≤ 7.5%</td> <td>-</td> <td>-</td> <td>-</td> <td>∞ 4.7uF</td> <td>∞ 4.7uF</td> </tr> <tr> <td rowspan="4">10V</td> <td>≤ 2.5%</td> <td>∞ 3.3nF</td> <td>∞ 10nF</td> <td>∞ 100nF</td> <td>∞ 330nF</td> <td>∞ 680nF</td> </tr> <tr> <td>≤ 3.5%</td> <td>∞ 15nF</td> <td>∞ 100nF</td> <td>∞ 330nF</td> <td>-</td> <td>∞ 2.2uF</td> </tr> <tr> <td>≤ 5%</td> <td>∞ 47nF</td> <td>-</td> <td>∞ 680nF</td> <td>∞ 2.2uF</td> <td>-</td> </tr> <tr> <td>≤ 7.5%</td> <td>-</td> <td>∞ 1uF</td> <td>∞ 2.2uF</td> <td>∞ 4.7uF</td> <td>∞ 10uF</td> </tr> <tr> <td rowspan="4">≤ 6.3V</td> <td>≤ 2.5%</td> <td>∞ 3.3nF</td> <td>-</td> <td>∞ 150nF</td> <td>-</td> <td>∞ 680nF</td> </tr> <tr> <td>≤ 3.5%</td> <td>∞ 15nF</td> <td>∞ 100nF</td> <td>∞ 330nF</td> <td>-</td> <td>∞ 2.2uF</td> </tr> <tr> <td>≤ 5%</td> <td>∞ 47nF</td> <td>∞ 220nF</td> <td>∞ 680nF</td> <td>-</td> <td>-</td> </tr> <tr> <td>≤ 7.5%</td> <td>-</td> <td>∞ 1uF</td> <td>-</td> <td>10~22uF</td> <td>∞ 10uF</td> </tr> <tr> <td></td> <td>≤ 10%</td> <td>∞ 4.7uF</td> <td>∞ 22uF</td> <td>∞ 47uF</td> <td>∞ 47uF</td> <td>∞ 100uF</td> </tr> </tbody> </table>	Voltage	DF	0201	0402	0603	0805	1206	≥ 100V	≤ 5%	-	∞ 10nF	∞ 100nF	∞ 330nF	∞ 680nF	50V	≤ 2.5%	∞ 3.3nF	∞ 10nF	∞ 100nF	∞ 330nF	∞ 680nF	≤ 3.5%	∞ 10nF	-	-	-	∞ 1uF	≤ 5%	-	-	-	∞ 680nF	-	≤ 10%	-	∞ 1uF	∞ 2.2uF	∞ 4.7uF	∞ 10uF	25V	≤ 2.5%	∞ 3.3nF	∞ 10nF	∞ 100nF	∞ 330nF	∞ 680nF	≤ 3.5%	∞ 10nF	∞ 100nF	∞ 330nF	-	∞ 2.2uF	≤ 5%	-	-	-	∞ 1uF	-	≤ 7.5%	-	-	-	∞ 2.2uF	∞ 4.7uF	16V	≤ 2.5%	∞ 3.3nF	∞ 10nF	∞ 100nF	∞ 330nF	∞ 680nF	≤ 3.5%	∞ 15nF	∞ 100nF	∞ 330nF	-	∞ 22uF	≤ 5%	∞ 47nF	∞ 220nF	∞ 680nF	∞ 22uF	-	≤ 7.5%	-	-	-	∞ 4.7uF	∞ 4.7uF	10V	≤ 2.5%	∞ 3.3nF	∞ 10nF	∞ 100nF	∞ 330nF	∞ 680nF	≤ 3.5%	∞ 15nF	∞ 100nF	∞ 330nF	-	∞ 2.2uF	≤ 5%	∞ 47nF	-	∞ 680nF	∞ 2.2uF	-	≤ 7.5%	-	∞ 1uF	∞ 2.2uF	∞ 4.7uF	∞ 10uF	≤ 6.3V	≤ 2.5%	∞ 3.3nF	-	∞ 150nF	-	∞ 680nF	≤ 3.5%	∞ 15nF	∞ 100nF	∞ 330nF	-	∞ 2.2uF	≤ 5%	∞ 47nF	∞ 220nF	∞ 680nF	-	-	≤ 7.5%	-	∞ 1uF	-	10~22uF	∞ 10uF		≤ 10%	∞ 4.7uF	∞ 22uF	∞ 47uF	∞ 47uF	∞ 100uF	NPO: (Class I) 1.0±0.2Vrms, 1MHz±10%  X7R/X7S/X5R: (Class II) Cap ≤ 10uF 1.0±0.2Vrms, 1KHz±10% Cap > 10uF 0.5±0.1Vrms, 120Hz±24Hz
Voltage	DF	0201	0402	0603	0805	1206																																																																																																																																														
≥ 100V	≤ 5%	-	∞ 10nF	∞ 100nF	∞ 330nF	∞ 680nF																																																																																																																																														
50V	≤ 2.5%	∞ 3.3nF	∞ 10nF	∞ 100nF	∞ 330nF	∞ 680nF																																																																																																																																														
	≤ 3.5%	∞ 10nF	-	-	-	∞ 1uF																																																																																																																																														
	≤ 5%	-	-	-	∞ 680nF	-																																																																																																																																														
	≤ 10%	-	∞ 1uF	∞ 2.2uF	∞ 4.7uF	∞ 10uF																																																																																																																																														
25V	≤ 2.5%	∞ 3.3nF	∞ 10nF	∞ 100nF	∞ 330nF	∞ 680nF																																																																																																																																														
	≤ 3.5%	∞ 10nF	∞ 100nF	∞ 330nF	-	∞ 2.2uF																																																																																																																																														
	≤ 5%	-	-	-	∞ 1uF	-																																																																																																																																														
	≤ 7.5%	-	-	-	∞ 2.2uF	∞ 4.7uF																																																																																																																																														
16V	≤ 2.5%	∞ 3.3nF	∞ 10nF	∞ 100nF	∞ 330nF	∞ 680nF																																																																																																																																														
	≤ 3.5%	∞ 15nF	∞ 100nF	∞ 330nF	-	∞ 22uF																																																																																																																																														
	≤ 5%	∞ 47nF	∞ 220nF	∞ 680nF	∞ 22uF	-																																																																																																																																														
	≤ 7.5%	-	-	-	∞ 4.7uF	∞ 4.7uF																																																																																																																																														
10V	≤ 2.5%	∞ 3.3nF	∞ 10nF	∞ 100nF	∞ 330nF	∞ 680nF																																																																																																																																														
	≤ 3.5%	∞ 15nF	∞ 100nF	∞ 330nF	-	∞ 2.2uF																																																																																																																																														
	≤ 5%	∞ 47nF	-	∞ 680nF	∞ 2.2uF	-																																																																																																																																														
	≤ 7.5%	-	∞ 1uF	∞ 2.2uF	∞ 4.7uF	∞ 10uF																																																																																																																																														
≤ 6.3V	≤ 2.5%	∞ 3.3nF	-	∞ 150nF	-	∞ 680nF																																																																																																																																														
	≤ 3.5%	∞ 15nF	∞ 100nF	∞ 330nF	-	∞ 2.2uF																																																																																																																																														
	≤ 5%	∞ 47nF	∞ 220nF	∞ 680nF	-	-																																																																																																																																														
	≤ 7.5%	-	∞ 1uF	-	10~22uF	∞ 10uF																																																																																																																																														
	≤ 10%	∞ 4.7uF	∞ 22uF	∞ 47uF	∞ 47uF	∞ 100uF																																																																																																																																														

**Automotive Grade Multilayer Ceramic Chip Capacitor**

Item	Requirement	Test Method															
DWV	No breakdown or damage on dielectric.	<p>Ur&lt;100V: Measuring Voltage: NPO: 300% Rated voltage X7R/X7S:250% Rated voltage</p> <p>Duration: 1~5s Charge / Discharge Current: 50mA max.</p> <p>100 ≤ Ur ≤ 630: Force 200% Rated Voltage for 5 seconds. Max current should not exceed 50 mA.</p>															
High Temperature Exposure	NPO: ΔC/C: ≤±1% or ±1pF whichever is larger X7R/X7S/X5R: ΔC/C: -12.5~+12.5% DF & IR: Same as initial value	<p>Temperature: 125±2°C Voltage: without Duration: 1000h Recovery conditions: Room temperature Recovery Time: 24h (NPO) or 48h(X7R/X7S/X5R)</p>															
Temperature Cycle	NPO: ΔC/C: ≤±1% or ±1pF whichever is larger X7R/X7S/X5R: ΔC/C: -10~+10% DF & IR: Same as initial value No damage on surface.	<p>Up-category temperature, 1h ; Recovery time: 24±1h Initial Measurement Cycling Times: 1000 times, 1 cycle, 4 steps:</p> <table border="1"> <thead> <tr> <th>Step</th> <th>Temperature</th> <th>Time</th> </tr> </thead> <tbody> <tr> <td>1</td> <td>-55°C</td> <td>30min</td> </tr> <tr> <td>2</td> <td>20°C</td> <td>1min</td> </tr> <tr> <td>3</td> <td>125°C</td> <td>30min</td> </tr> <tr> <td>4</td> <td>20°C</td> <td>1min</td> </tr> </tbody> </table> <p>Recovery time after test: 24±2h</p>	Step	Temperature	Time	1	-55°C	30min	2	20°C	1min	3	125°C	30min	4	20°C	1min
Step	Temperature	Time															
1	-55°C	30min															
2	20°C	1min															
3	125°C	30min															
4	20°C	1min															
Temperature shock	NPO: ΔC/C: ≤±1% or ±1pF whichever is larger X7R/X7S/X5R: ΔC/C: -10~+10% DF & IR: Same as initial value No damage on surface.	<p>Up-category temperature, 1h ; Recovery time: 24±1h Initial Measurement Cycling Times: 1000 times: Recovery time after test: 24±2h</p>															
Destructive Physical Analysis	No defects or abnormalities	Accounting to EIA-469															
Biased Humidity	NPO: ΔC/C: ≤±2.5% or ±2.5pF whichever is larger X7R/X7S/X5R: ΔC/C: -12.5~+12.5% DF & IR: Same as initial value No damage on surface.	<p>At 140°C~150°C 1 hour, then keep for 24 ±1 hour at room temp.</p> <p>Test condition : 85±2 °C, 80~85% R.H. Add 100 KΩ resistor, applied Ur for 1,000 hours</p>															
Physical Dimension	Within the specified dimensions	Use caliper															
Appearance	No visible damage	Visual inspection															
Vibration	NPO: ΔC/C: ≤±1% or ±1pF whichever is larger X7R/X7S:ΔC/C: -10~+10% DF / IR: Same to initial value Appearance: No visible damage	<p>5 g's for 20 minutes, 12 cycles each of 3 orientations. Note: Use 8" x 5" PCB. 0.31" thick 7 secure points on one long side and 2 secure points at corners of opposite sides. Parts mounted within 2" from any secure point. Test from 10-2000 Hz.</p>															
Mechanical Shock	NPO: ΔC/C: ≤±1% or ±1pF whichever is larger X7R/X7S:ΔC/C: -10~+10% DF / IR: Same to initial value Appearance: No visible damage	<p>Three shocks in each direction shall be applied along the three mutually perpendicular axes of the test specimen (18 shocks) Waveform: Half-sin Peak value: 1,500 g's Duration: 0.5 ms Velocity change: 4.7 m/s</p>															
Solderability	At least 95% of the terminal electrode is covered by new solder. Visual Appearance: No visible damage.	<p>Preheating conditions:80 to 120°C; 10~30s.</p> <table border="1"> <tr> <td>Solder Temperature: 235±5°C (Sn/Pb:63/37) Duration: 2±0.5s</td> <td>Solder Temperature: 245±5°C (Lead-free) Duration: 3±0.3s</td> </tr> </table>	Solder Temperature: 235±5°C (Sn/Pb:63/37) Duration: 2±0.5s	Solder Temperature: 245±5°C (Lead-free) Duration: 3±0.3s													
Solder Temperature: 235±5°C (Sn/Pb:63/37) Duration: 2±0.5s	Solder Temperature: 245±5°C (Lead-free) Duration: 3±0.3s																
Life Test	NPO: ΔC/C: ≤±2.5% or ±2.5pF whichever is larger X7R/X7S/X5R: ΔC/C: ≤±12.5% DF: Same to initial value IR: NPO: Ri≥5000MΩ或 Ri•CR≥50S whichever is smaller X7R/X7S/X5R: Ri≥1000MΩ或 Ri•CR≥10S whichever is smaller Appearance: No visible damage.	<p>Applied Voltage: Ur &lt; 100V : 2x Rated Voltage 100V≤Ur &lt; 500V : 2x Rated Voltage 500V≤Ur≤630V : 1.5x Rated Voltage Duration: 1000h Temperature : 125°C Charge/ Discharge Current: 50mA max. Recovery Conditions: Room Temperature Recovery Time: 24h (NPO) or 48h(X7R/X7S/X5R)</p>															

**Automotive Grade Multilayer Ceramic Chip Capacitor**

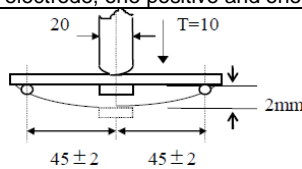
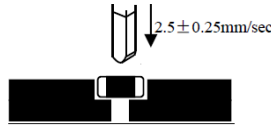
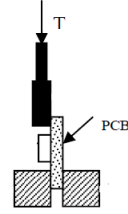
Item	Requirement	Test Method
Resistance to Soldering Heat	NPO: $\Delta C/C$ : $\leq \pm 1\%$ or $\pm 1\text{pF}$ whichever is larger X7R/X7S/5X5R: $\Delta C/C$ : $-15\% \sim +15\%$ DF / IR: Same to initial value Appearance : No visible damage. At least 95% of the terminal electrode is covered by new solder.	Preheating conditions: 100 to 200°C; 60~120s. Solder Temperature: 265±5°C Duration: 10±1s Clean the capacitor with solvent and examine it with a 10X(min.) microscope. Recovery Time: 24±2h Recovery condition: Room temperature
ESD	NPO/X7R/X7S: C&DF&IR: Same to initial value Appearance : No visible damage	Conditions: contact discharge Discharge voltage: 500V Each sample was subjected to two discharges at each electrode, one positive and one negative.
Resistance to Flexure of Substrate (Bending Strength)	NPO: $\Delta C/C$ : $\leq \pm 1\%$ or $\pm 1\text{pF}$ whichever is larger X7R/X7S: $\Delta C/C$ : $-10\% \sim +10\%$ DF / IR: Same to initial value Appearance: No visible damage	 <p>Test Board: Al<sub>2</sub>O<sub>3</sub> or PCB Warp: 2mm Speed: 0.5mm/sec. Unit: mm The measurement should be made with the board in the bending position.</p>
Beam Load Test	$\leq 0805$ : thickness >0.5mm, 20N thickness $\leq 0.5\text{mm}$ , 8N $\geq 1206$ : thickness >1.25mm, 54N thickness $\leq 1.25\text{mm}$ , 15N	Products in the process of testing the procelain body when fracture force must be greater than the minimum pressure. 
Terminal Strength(SMD)	NPO: $\Delta C/C$ : $\leq \pm 0.5\%$ X7R/X7S: $\Delta C/C$ : $-10\% \sim +10\%$ DF / IR: Same to initial value Appearance: No visible damage	Slowly put a T of force on the capacitor side porcelain body, and keep the 60+1 s 0402:4N 0603:10N >0603:17.7N 
Temperature Character	NPO: $\Delta C/C$ : $\pm 0.2\%$ or $\pm 0.05\text{pF}$ X7R: $\Delta C/C$ : $\pm 15\%$ X7S: $\Delta C/C$ : $\pm 22\%$	At -55°C, 20°C, 125°C

■ Storage Temperature: 5~40°C; Humidity: 20~70%RH

**■ Temperature Coefficient / Characteristics**

Dielectric	Reference Temperature Point	Temperature Coefficient	Operation Temperature Range
NPO(COG)	20°C	0±30 ppm/°C	-55°C~125°C
X5R	20°C	±15%	-55°C~85°C
X7R	20°C	±15%	-55°C~125°C
X7S	20°C	±22%	-55°C~125°C

Note : Nominal temperature coefficient and allowed tolerance of class I are decided by the changing of the capacitance between 20°C and 85°C.  
 Nominal temperature coefficient of class II are decided by the temperature of 20°C



**Automotive Grade Multilayer Ceramic Chip Capacitor**

**■Packaging**

Packaging Quantity

Type	Thickness	Packaging (7" Reel)	
		Paper tape	Plastic tape
0201	0.30±0.05	15K	-
0402	0.50±0.05	10K	-
	0.50±0.15	10k	-
0603	0.80±0.10	4K	-
	0.80±0.20	4K	-
0805	0.80±0.20	4K	-
	1.25±0.20	-	3K
0805 X7R 25V 475	1.25±0.20	-	2K
1206	0.80±0.20	4K	-
	1.25±0.20	-	3K
	1.60±0.30	-	2K
1210	≤2.80	-	T ≤1.80mm 2K
		-	T >1.80mm 1K
1808	≤2.20	-	2K
1812	≤3.50	-	T ≤1.85mm 1K
		-	T >1.85mm 0.5K
2220	≤3.50	-	0.5K

Tape and Reel

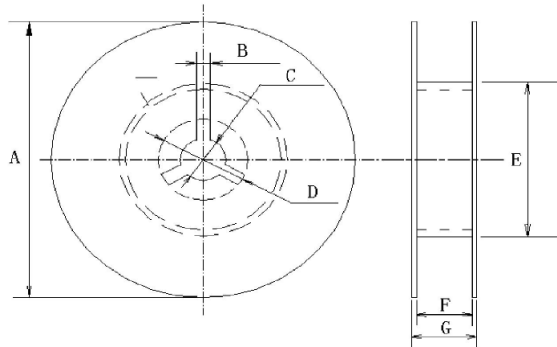

Unit: mm

Type	A	B	C	D	E	F	G
0201	178±2.0(7")	3.0	13.0±0.5	21.0±0.8	50 or more	10.0±1.5	12 max
0402	178±2.0(7")	3.0	13.0±0.5	21.0±0.8	50 or more	10.0±1.5	12 max
0603	178±2.0(7")	3.0	13.0±0.5	21.0±0.8	50 or more	10.0±1.5	12 max
0805	178±2.0(7")	3.0	13.0±0.5	21.0±0.8	50 or more	10.0±1.5	12 max
1206	178±2.0(7")	3.0	13.0±0.5	21.0±0.8	50 or more	10.0±1.5	12 max
1210	178±2.0(7")	3.0	13.0±0.5	21.0±0.8	50 or more	10.0±1.5	12 max
1808	330±2.0(13")	3.0	13.0±0.5	21.0±0.8	50 or more	12.6 max	13.6 max
1812	330±2.0(13")	3.0	13.0±0.5	21.0±0.8	50 or more	12.6 max	13.6 max
2220	330±2.0(13")	3.0	13.0±0.5	21.0±0.8	50 or more	12.6 max	13.6 max

**Automotive Grade Multilayer Ceramic Chip Capacitor**

Paper Tape Size Specification

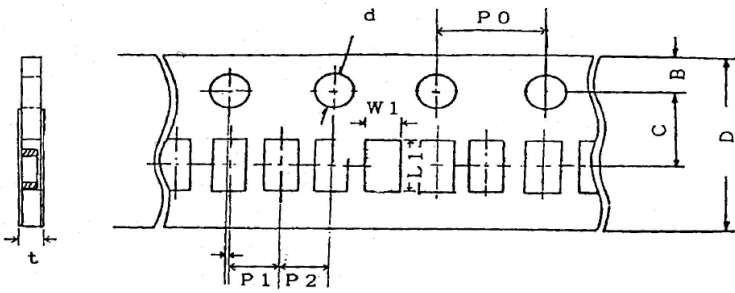

Unit: mm

Type	0201	0402
W1	0.37±0.10	0.65±0.10
L1	0.67±0.10	1.15±0.10
D	8.00±0.10	8.00±0.10
C	3.50±0.05	3.50±0.05
B	1.75±0.10	1.75±0.10
P1	2.00±0.05	2.00±0.05
P2	2.00±0.05	2.00±0.05
P0	4.00±0.10	4.00±0.10
d	1.50-0/+0.10	1.50-0/+0.10
t	0.80 Below	0.80 Below

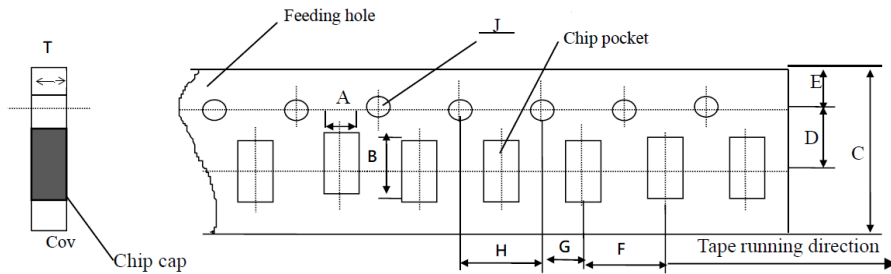

Unit: mm

Type	0603	0805	1206
A	1.10±0.10	1.45±0.15	1.80±0.20
B	1.90±0.10	2.30±0.15	3.40±0.20
C	8.00±0.10	8.00±0.15	8.00±0.20
D	3.50±0.05	3.50±0.05	3.50±0.05
E	1.75±0.10	1.75±0.10	1.75±0.10
F	4.00±0.10	4.00±0.10	4.00±0.10
G	2.00±0.10	2.00±0.10	2.00±0.10
H	4.00±0.10	4.00±0.10	4.00±0.10
J	1.50-0/+0.10	1.50-0/+0.10	1.50-0/+0.10
T	1.10 max	1.10 max	1.10 max

**Automotive Grade Multilayer Ceramic Chip Capacitor**

Plastic Tape Size Specification

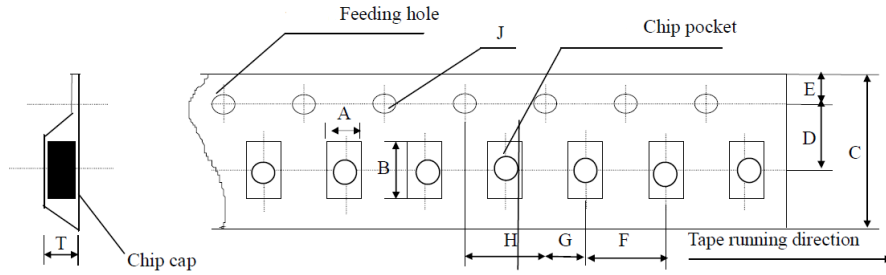

Unit: mm

Type	0805	1206	1210	1808	1812	2220
A	1.55±0.20	1.95±0.20	2.70±0.10	2.20±0.10	3.66±0.10	6.20±0.10
B	2.35±0.20	3.60±0.20	3.42±0.10	4.95±0.10	4.95±0.10	6.70±0.10
C	8.00±0.20	8.00±0.20	8.00±0.10	12.00±0.10	12.00±0.10	12.00±0.10
D	3.50±0.05	3.50±0.05	3.50±0.05	5.50±0.05	5.50±0.05	5.50±0.05
E	1.75±0.10	1.75±0.10	1.75±0.10	1.75±0.10	1.75±0.10	1.75±0.10
F	4.00±0.10	4.00±0.10	4.00±0.10	4.00±0.10	8.00±0.10	8.00±0.10
G	2.00±0.10	2.00±0.10	2.00±0.05	2.00±0.05	2.00±0.05	2.00±0.05
H	4.00±0.10	4.00±0.10	4.00±0.10	4.00±0.10	4.00±0.10	4.00±0.10
J	1.50-0/+0.10	1.50-0/+0.10	1.55-0/+0.10	1.50-0/+0.10	1.55-0/+0.10	1.55-0/+0.10
T	1.50 Max	1.85 Max	3.20 Max	3.00 Max	4.00 Max	2.40±0.10

**Recommended Soldering Profile**

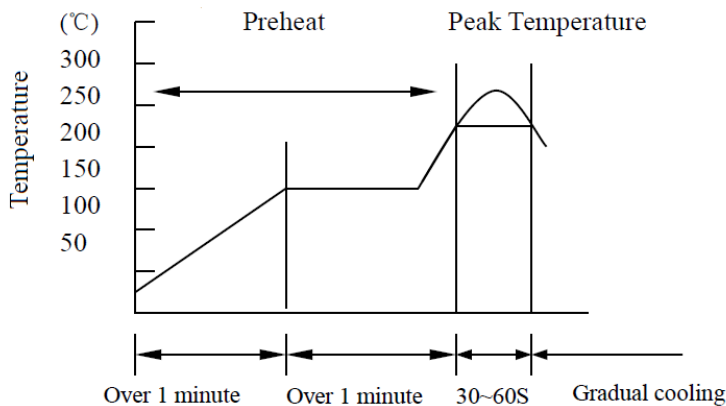

	Pb-Sn soldering	Lead-free soldering
Peak Temperature	230 ~ 250°C	240 ~ 260°C

Keep the temperature difference between soldering temperature and surface temperature of chips as:  $T \leq 150^\circ\text{C}$  during preheating.